

CARB toroidal roller bearings, cylindrical and tapered bore

Principal dimensions			Basic load ratings		Speed ratings		Designation	
d	D	B	dynamic C	static C0	Reference speed	Limiting speed	* SKF Explorer bearing	** Check availability
mm			kN		r/min		-	
<b>50</b>	72	40	140	224	-	2400	<b>C 6910 V *</b>	-

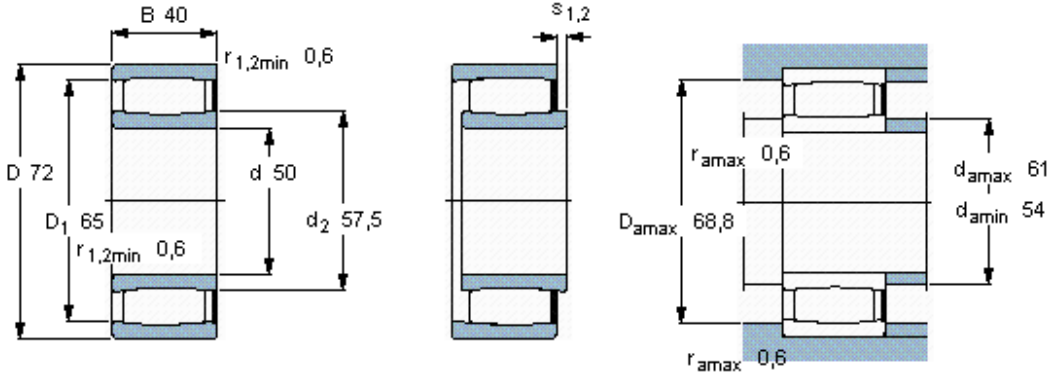

<b>Axial displacement <math>s_1</math></b>	9,4	
<b>Axial displacement <math>s_2</math> (retaining ring side)</b>	6,4	
<b>Misalignment factor <math>k_1</math></b>	0,093	
<b>Operating clearance factor <math>k_2</math></b>	0,113	